











Self-contained ice maker - Sprayer system Daily production up to 34 kg

Hotel	████████████████████
Restaurant	████████████████████
Fast food	████████████████████
Bar	████████████████████
Disco	████████████████████
Fish market	████████████████████
Supermarket	████████████████████
Medical & SPA	████████████████████
Industry	████████████████████

► Position n°



► Features & Plus

- Compact and crystal cube
- AISI 304 SS Scotch Brite finish 
- Tropical class +43°C 
- Removable and cleanable air filter
- Air or water cooling system
- Easy cleanable internal rounded surfaces 
- HCFC-Free insulated storage 
- RoHS Free 
- Disappearing insulated door 
- Electromechanical operation 
- ON-OFF rocker switch 
- Standard and special voltages



AISI 304 SS Scotch Brite finish



Removable and cleanable air filter



Easy cleanable internal rounded surfaces



Disappearing insulated door

► Available ice cube size

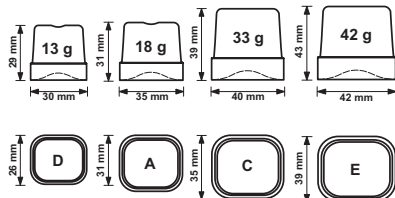

► Prod. 24h

Air temp.	Water temp.	kg	lbs		
		10° C	50° F	7° C	45° F
21° C	70° F	15° C	60° F	29	64

2 Years Warranty
subject to limitations

► Certifications available for this model





Ice Cube

CB 249

Self-contained ice maker - Sprayer system
Daily production up to 34 kg

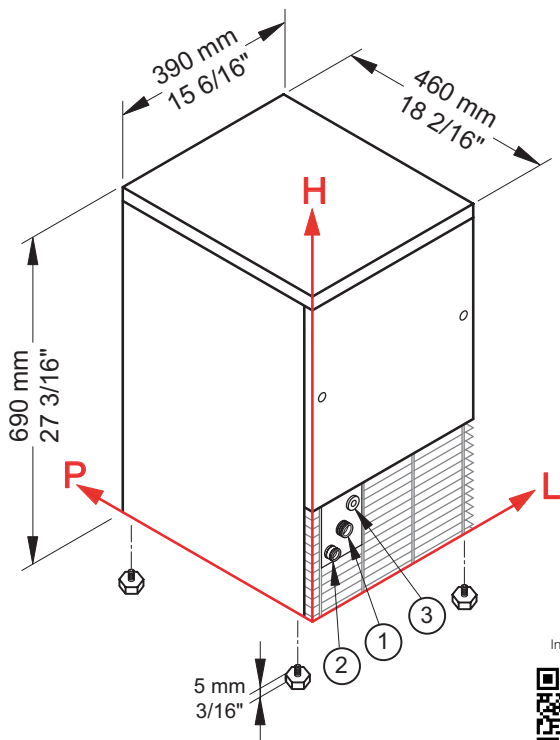
**▶ Working conditions**

- Location: **Indoor**

	Min	Max
Ambient temperature	+10° C / +50° F	+43° C / 110° F
Water temperature	+3° C / +37° F	+32° C / +90° F
Voltage	-10%	+10%
Water inlet pressure	1bar (14 psi)	6bar (84 psi)

▶ Performances

	Air temperature	Water temperature	Water temperature					
			7° C	45° F	15° C	60° F	21° C	70° F
	10° C	34 kg						
	50° F	75 lbs						
	21° C			29 kg				
	70° F			64 lbs				
	32° C					26 kg		
	90° F						57 lbs	

▶ Connections

All measures are referred to the rear bottom-left corner (L-H-Ø)

- ① Water in.: 111 mm / 4 6/16" - 175 mm / 6 14/16" - 3/4" ② Water out.: 49 mm / 1 15/16" - 130 mm / 5 2/16" - 24 mm / 15/16"
 ③ Electrical connections: 156 mm / 6 2/16" - 211 mm / 8 5/16"

▶ Technical information

Production in 24h	29 kg / 64 lbs
Store capacity, up to	9 kg / 20 lbs
Cooling system	A - W
Kind of cube	A-18g, C-33g, D-13g, E-42g
Refrigerant	R404A - R452A
Standard voltage	220-240 V ~ 50 Hz
Average power consumption	370 W
Fuse	10 A
Finish	AISI 304 stainless steel, scotch brite

Water consumption	A: 5,1 l/kg - 61,1 gal/100 lbs
	W: 14 l/kg - 167,8 gal/100 lbs
Sizes (L-P-H mm)	390 - 460 - 690
(L-P-H in)	15 6/16 - 18 2/16 - 27 3/16
Sizes with pack (L-P-H mm)	440 - 520 - 880
(L-P-H in)	17 5/16 - 20 8/16 - 34 10/16
Net weight	37 kg / 82 lbs
Gross weight	44 kg / 97 lbs

All the technical information need to be considered at the following conditions:

Standard Cube (18 g)
 Ambient temperature +21° C
 Water temperature +15° C
 Average power consumption at +43° C (standard voltage)
 Refrigerant R404A

Models and specifications are subject to change without notice

Rev. 03 - Issued May 2018



www.bremaice.it
info@bremaice.it

